

3.3

I-Beam Fixed to Steel Beam with Face Mount Hanger

Option 2

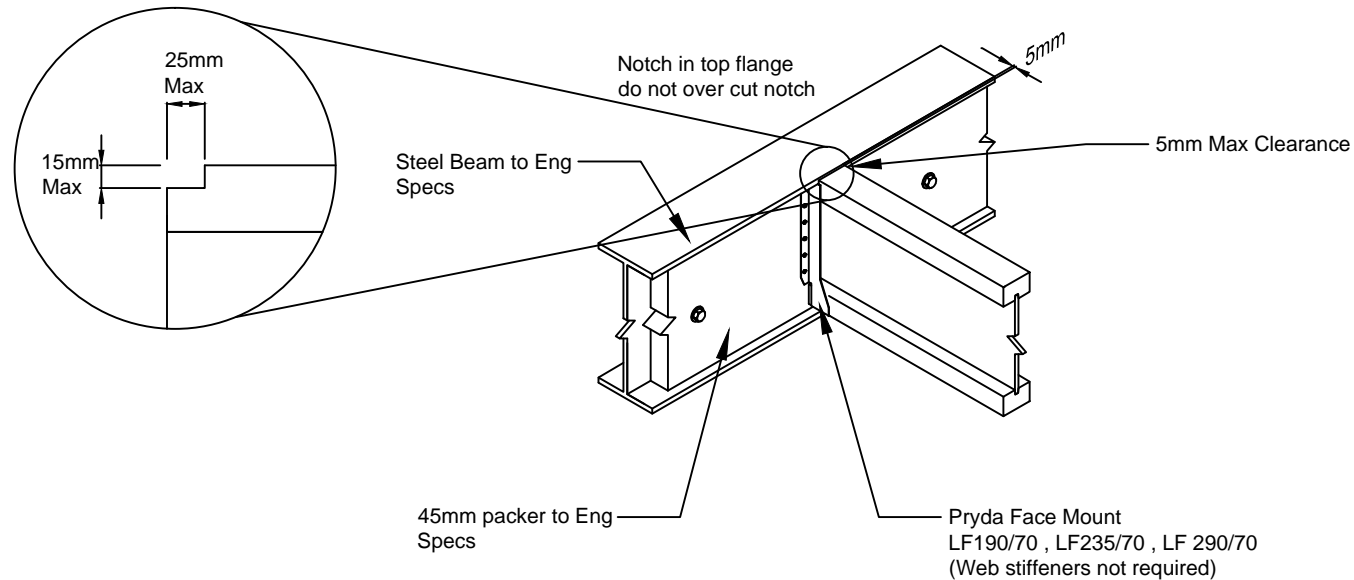

GENERAL NOTES:

1. These details are intended to be used in the construction industry by suitably qualified designers and builders.
2. I-Built details are to be read in conjunction with the Architectural Drawings, Engineers Drawings, NZS3604:2011 and the I-Built Design and Installation Guide.
3. Builder is to double check all measurements prior to installation of all items.
4. Before cutting or drilling into I-Beams refer to Hole Charts or contact the I-Built team for positioning guidance.
5. These construction details should not be altered or amended in any way.
6. Contact the I-Built technical team on 0800 022 352 or techinfo@nzwoodproducts.co.nz with any questions.